



HT5380系列 变频输入专用滤波器

- 适用于三相三线供电的工业设备、仪器，如电磁炉、电焊机等
- 有效抑制设备本身对电网的电磁干扰
- 适用于变频器输入端,使之符合EN 61800-3/GB 21668.3
- 另有HT5380G系列用于预防电网中高频杂波对设备的干扰，避免造成误动作



型 号	额定电流 A	连接方式			外壳
		 焊片	 螺栓	 铜排	
HT5380-6-M4-C31	6	--	M4	--	C31
HT5380-6-L8-C31	6	L8	--	--	C31
HT5380-8-M4-C31	8	--	M4	--	C31
HT5380-8-L8-C31	8	L8	--	--	C31
HT5380-10-M4-C31	10	--	M4	--	C31
HT5380-10-L8-C31	10	L8	--	--	C31
HT5380-13-M4-E32	13	--	M4	--	E32
HT5380-13-L8-E32	13	L8	--	--	E32
HT5380-16-M4-E32	16	--	M4	--	E32
HT5380-16-L8-E32	16	L8	--	--	E32
HT5380-20-M4-E32	20	--	M4	--	E32
HT5380-20-L8-E32	20	L8	--	--	E32
HT5380-25-M4-E32	25	--	M4	--	E32
HT5380-32-M6-G32	32	--	M6	--	G32
HT5380-42-M6-G32	42	--	M6	--	G32
HT5380-50-M6-G33	50	--	M6	--	G33
HT5380-65-M6-G33	65	--	M6	--	G33
HT5380-80-M8-G35	80	--	M8	--	G35
HT5380-100-M8-G35	100	--	M8	--	G35
HT5380-120-M8-G35	120	--	M8	--	G35
HT5380-150-M10-G36	150	--	M10	--	G36
HT5380-180-M10-G36	180	--	M10	--	G36
HT5380-250-Bar-Y5A	250	--	--	Bar	Y5A
HT5380-420-Bar-Y6A	420	--	--	Bar	Y6A
HT5380-630-Bar-Y7A	630	--	--	Bar	Y7A
HT5380-800-Bar-Y10A	800	--	--	Bar	Y10A
HT5380-1000-Bar-Y10A	1000	--	--	Bar	Y10A

* 连接方式：L8-焊片（6.3*0.8）；M4-M4螺栓；M6-M6螺栓；M8-M8螺栓；M10-M10螺栓；Bar-铜排。



HUGETON
惠博顿

HT5380系列 变频输入专用滤波器

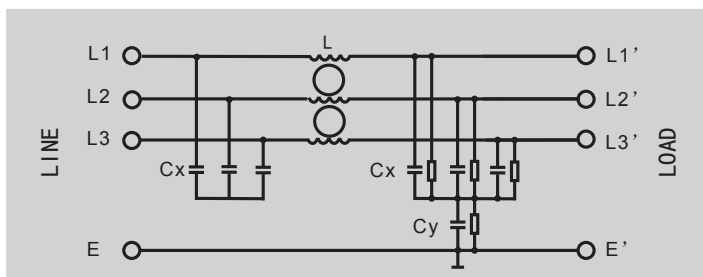

工作频率:50/60Hz
 额定电压:440VAC
 额定电流:6~1000A(50℃时),最大值
 耐压测试(2秒钟):
 2250VDC(L-L) 2700VDC(L-E)
 温度范围:-25℃~+100℃

插入损耗

符合IEC/CISPR NO.17

50Ω/50Ω共模: ——— 50Ω/50Ω差模: - - - - -

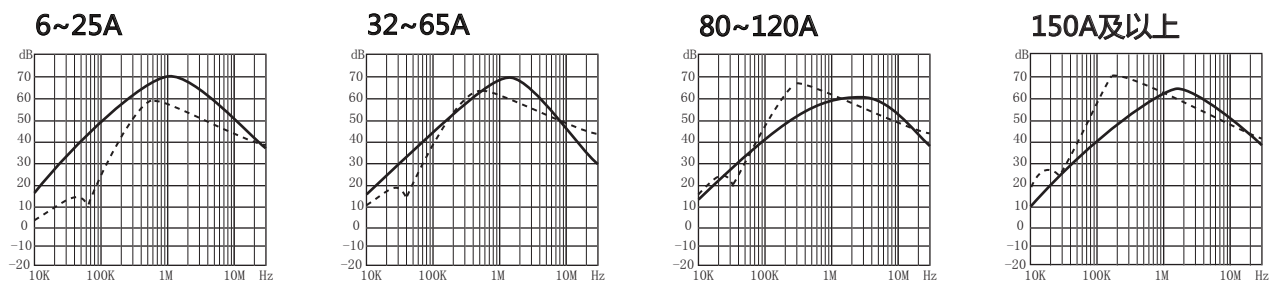

外形尺寸

单位: mm 公差: ±1

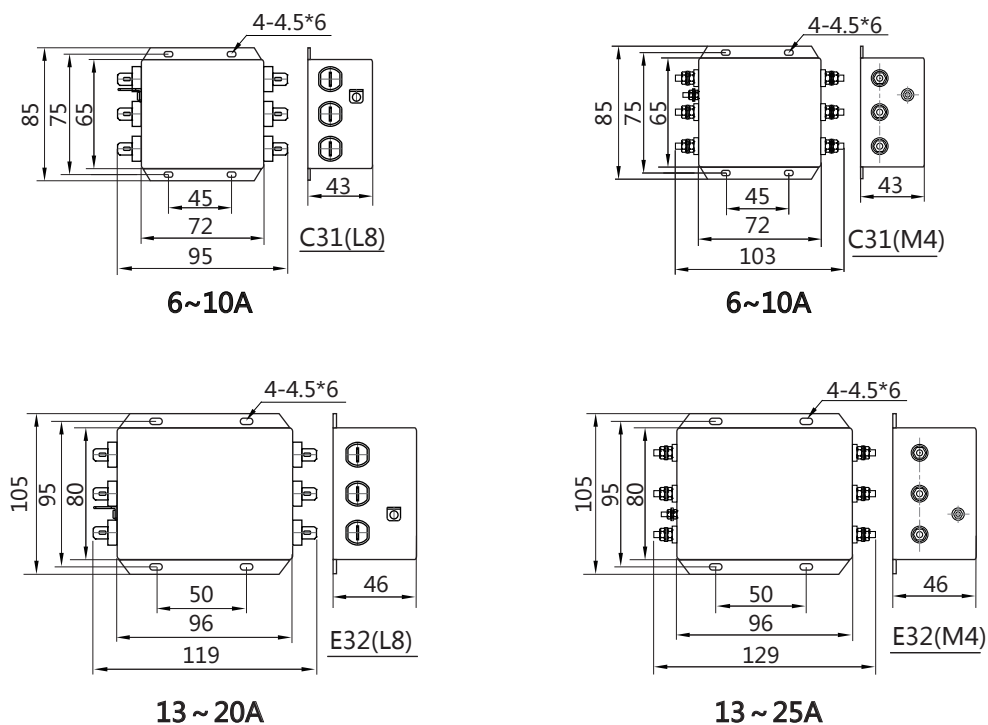



HUGETON

惠博顿

HT5380系列 变频输入专用滤波器

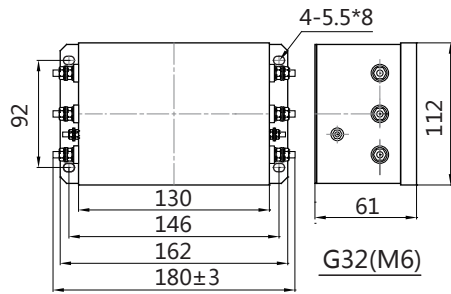

32 ~ 42A

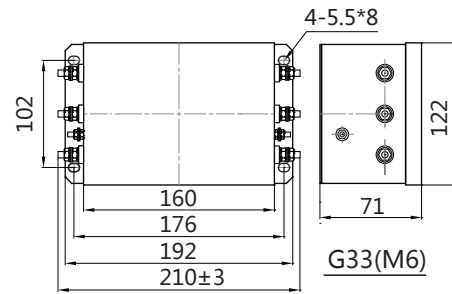

50 ~ 65A

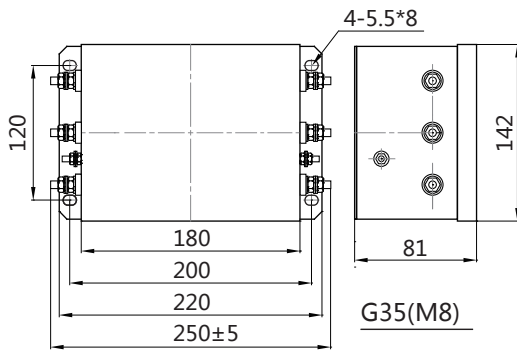

80 ~ 120A

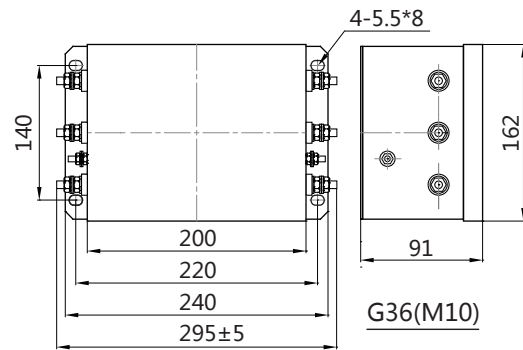

150A ~ 180A

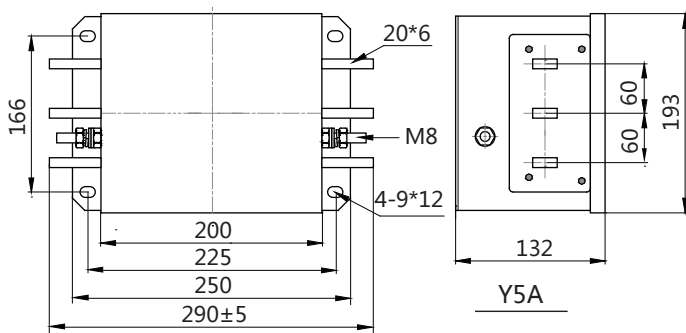

250A

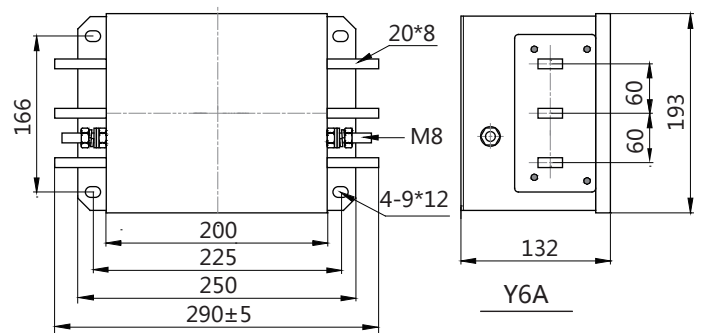

420A

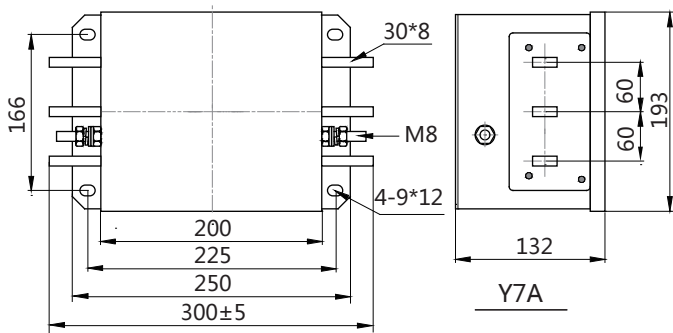

630A

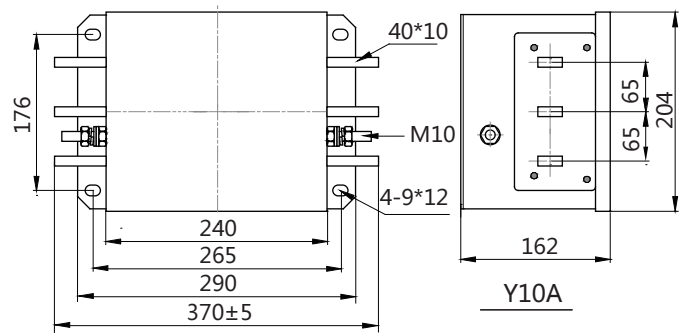

800 ~ 1000A